

Installation Instructions Chameleon[®] WL

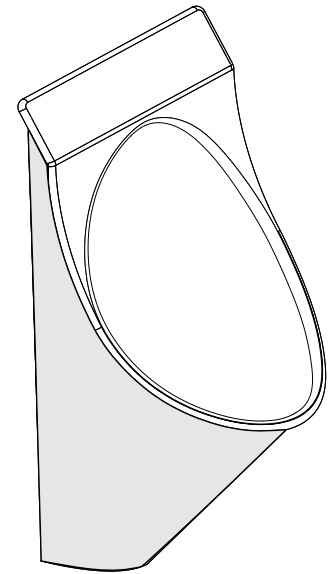





IMPORTANT

- THE URINAL MUST BE INSTALLED IN ACCORDANCE WITH THE AS/NZS 3500.2 PLUMBING REQUIREMENTS.
 - ENSURE THAT ALL DRAINPIPES ARE WELL CLEANED AND ARE FREE FROM BLOCKAGES.
 - THE UNDILUTED DISCHARGE FROM A WATERLESS URINAL SHALL NOT BE TRANSPORTED THROUGH COPPER OR COPPER ALLOY PIPEWORK.
 - FOR TIMBER STUD WALLS THE NOGGINS AND STUDS MUST BE POSITIONED AT A HEIGHT TO ALLOW FOR THE LOCATION OF THE FASTENERS. FOR MORE REGARDING MEASUREMENT SEE FIG.1 ON PAGE 2.
- PLEASE GIVE THE ENCLOSED ENVELOPE WITH THE CLEANING/MAINTENANCE INSTRUCTIONS AND WARRANTY DETAILS TO THE CUSTOMER**

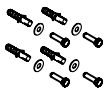

Chameleon WL
Waterless Urinal

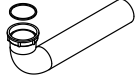
Fittings Included in the Box

- A** 4 x 
Plugs, Washers, Screws
- B** 1 x 
Rubber Seal for 50DN Waste Pipe
- C** 1 x 
90 Degree Drain Connector with Washer
- D** 1 x 
D-Valve with Installation Key

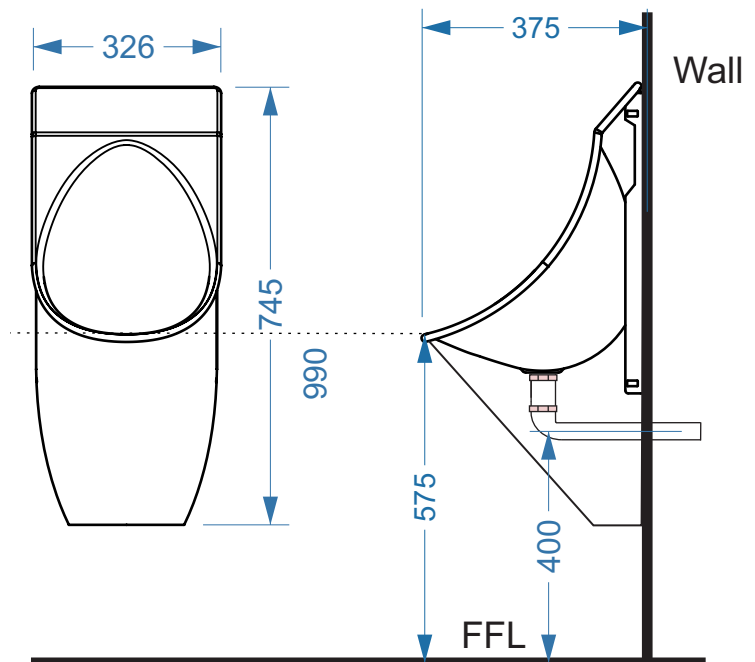

STEP BY STEP INSTALLATION ON PAGE 2

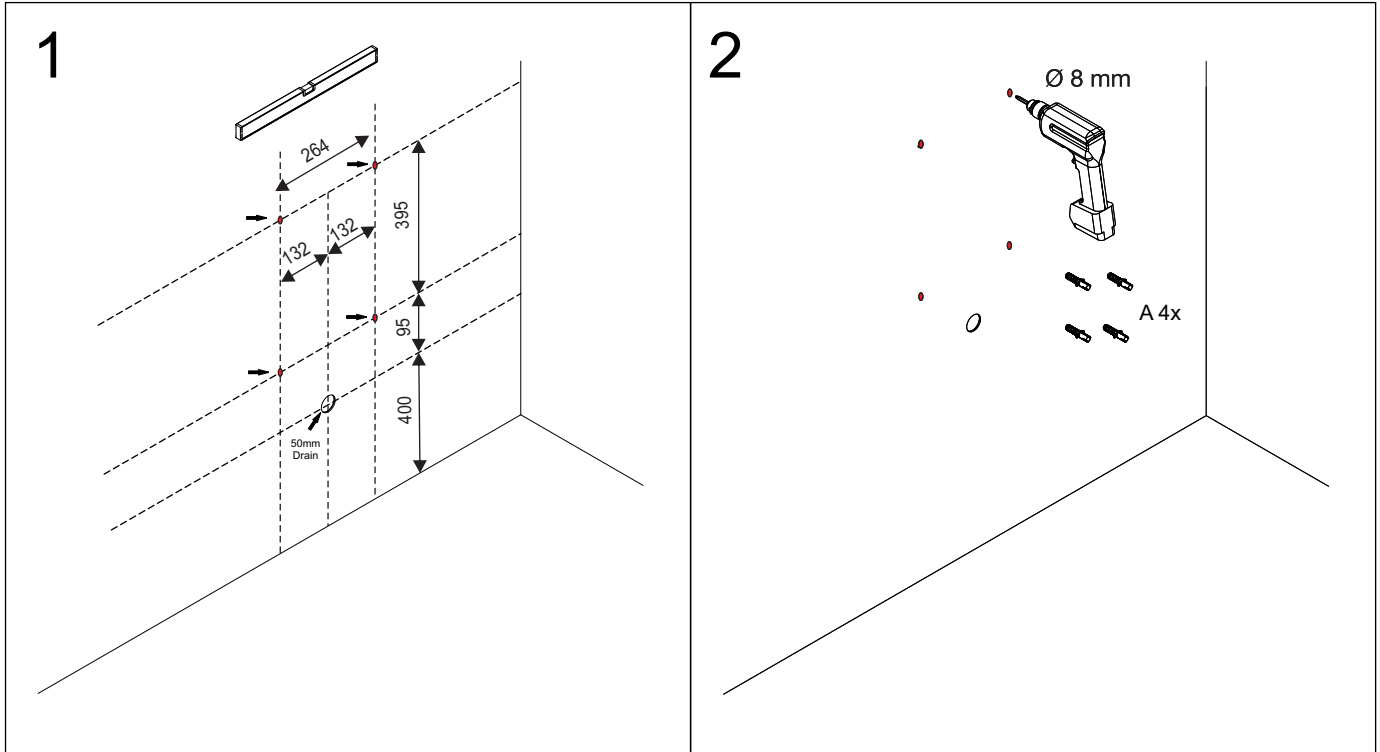

Mark 4 holes for mounting plate

Drill the 4 marked holes and fix the plugs (A)

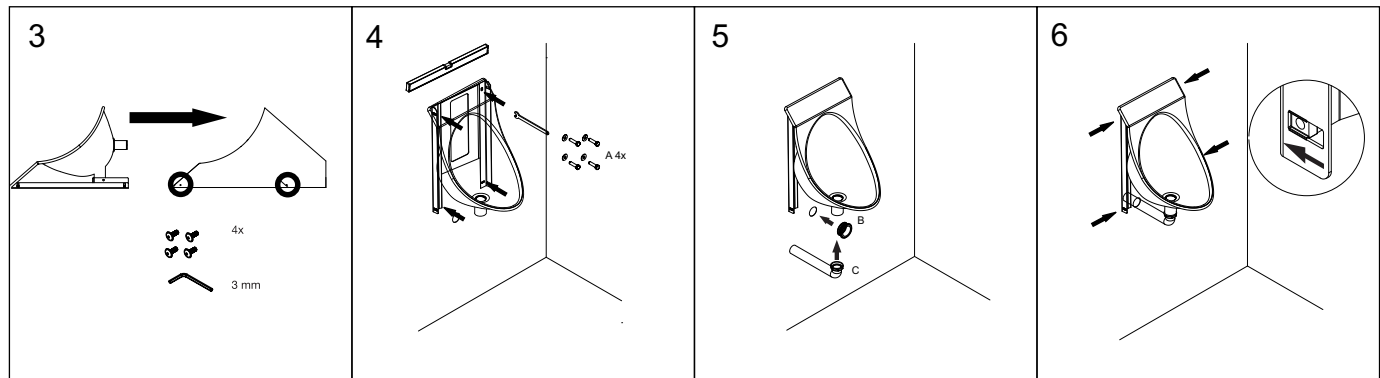

Unscrew and slide the skirt off from the mounting plate as per Fig. 3

Use level and install the mounting plate with screws and washer (A).

Push the rubber seal (B) into the 50 mm drain. Add lubricant to the 90 drain connector (C) and push it into the rubber seal and connect.

Slide all 4 pre-mounted cage nuts towards the back wall.

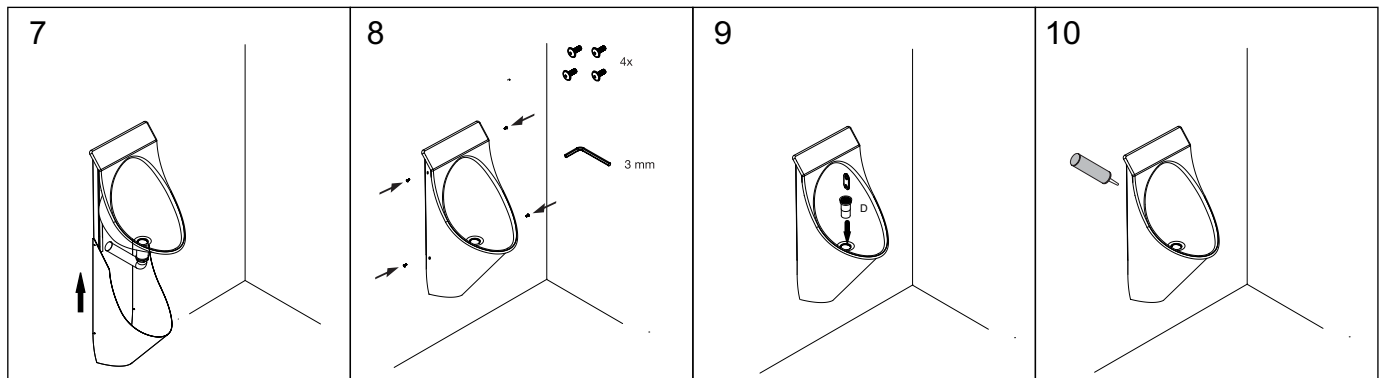

Attach the skirt by gliding it from below into position and align the nuts in FIG. 6

Put the skirt into place, level and screw into the nuts.

Insert the D-Valve (D) into the adapter and fix it with a gentle clockwise rotation.

Seal the outer edge of urinal to the wall with silicon.